

OSTIN

OSTIN

BALMA®

Design:
Piotr Kuchciński





Prosta, wyrazista forma mebli gabinetowych OSTIN zainspirowana została geometrią współczesnej modernistycznej architektury. Zaprojektowane dla odbiorcy wymagającego, z ukształtowanym gustem, świadomego swych potrzeb i wysokich oczekiwań. Uzupełniają i dopełniają osobowość użytkownika.

Simple and distinctive form of OSTIN office furniture is inspired by the geometry of the contemporary modernistic architecture. The furniture is designed for demanding customers with an established taste, aware of their needs and high expectations. It complements and supplements the user's personality.

Ich wyrafinowanie, funkcjonalność oraz konwencja estetyczna sprawiają, że przestrzeń biurowa, w której się znajdują nabiera niezwyklej jakości. Meble OSTIN wypełniają ją kreatywną energią, stymulują i inspirują do podejmowania wyzwań, śmiałych, dynamicznych decyzji, otwierają szersze horyzonty. Zapewniają komfort, satysfakcję i poczucie luksusu.

Its refinement, functionality and aesthetic convention make the office space assume extraordinary quality. OSTIN furniture fills the office space with creative energy, stimulates users to face challenges, inspires them to take bold, dynamic decisions, and opens up broader horizons. The furniture ensures comfort, satisfaction and the sense of luxury.





03-01 03-09 03-13 03-18 3 03-32



Kształty biurk i stołów, choć z założenia nowoczesne, przywodzą na myśl archetypiczne formy. Biurka mają strukturę płytową, wolnostojące lub wsparte na komodach; stoły konferencyjne oparte na czterech nogach. Wykonane są z płyty o grubości 43 mm pokrytej melaminą lub okleiną naturalną w szerokim wyborze kolorów. Dostojne, pełne elegancji bryły wzbogacają oryginalne, dyskretne detale, zauważalne dopiero przy bliskim kontakcie z meblami.

The shapes of desks and tables, even though modern as such, resemble archetypical forms. Desks are made of boards, and are available as free standing or resting on chests of drawers; conference tables are equipped with four legs. They are made of board covered by melamine or natural veneer available in a wide range of colours. Dignified and full of elegance, furniture bodies are enriched by original, discreet details which are only noticeable upon a closer look.



Komody i szafy, choć bryły ich z pozoru proste, wyróżniają się niezwykleymi rozwiązaniami. Drzwi i czoła szuflad pozbawione uchwytów, rozdzielone są charakterystycznymi aluminiowymi szczelinami, skomponowanymi w linearną grafikę. Wieńce górne wsunięte i opuszczone między boki i fronty zaskakują nietypowym wykończeniem – w całości wyklejone skórą ekologiczną, stanowią efektowny, zmysłowy i innowacyjny wyróżnik tego systemu.

Chests of drawers and cabinets, even though their bodies are apparently simple, are distinguished by unusual solutions. Doors and fronts of drawers have no handles, they are separated by characteristic aluminium gaps, composed into linear graphics. Top rims, recessed and sunk between sides and fronts, surprise with non-standard finish – they are entirely lined with eco-leather and thus form an effective, sensuous and innovative distinguishing factor of the system.





03-02 03-03 03-08

03-35



03-08



03-33

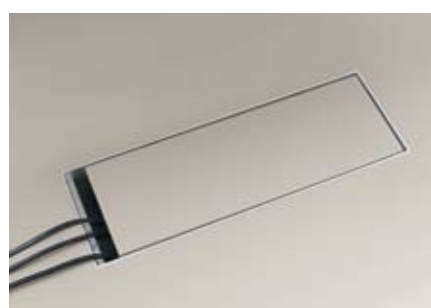

03-33





Szczególnym, wyrazistym elementem systemu OSTIN są wiszące regały – kwadratowy i prostokątny. Poza naturalną funkcjonalnością, ich największą wartością jest niezwykła dekoracyjność – zawieszane na ścianie (pojedynczo lub w większych kompozycjach o nieograniczonej liczbie kombinacji) wyglądają jak modernistyczna rzeźba, relief i z powodzeniem zastępują obrazy, grafiki. Dzięki nim przestrzeń biurowa wyłamuje się ze schematów.

A particularly distinctive feature of the OSTIN system are bookshelves – square and rectangular. Apart from their natural functionality, their decorative nature forms their greatest value – hung on walls (as single shelves or larger units with an unlimited number of combinations) they look like a modernist relief and can just as well replace pictures or graphics. They make the office space break established patterns.



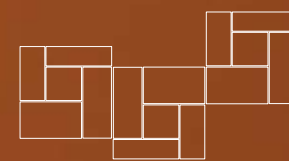
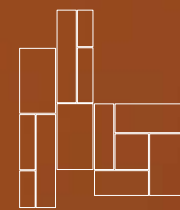
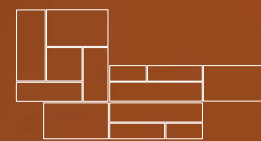
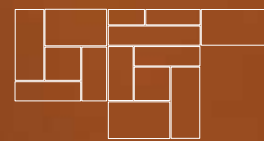
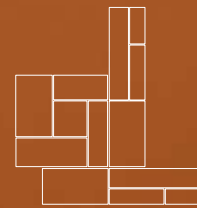
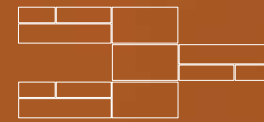











Architektura szaf i komód zaprojektowana została tak, by tworzyły one szczególnie atrakcyjne wizualnie i spójne kompozycje podczas zestawiania z sobą brył o różnych wysokościach. Dodatkowe zastosowanie dwóch kolorów na frontach tworzy iluzję ich wzajemnego przenikania. To wyjątkowe i oryginalne rozwiązanie. Korpusy szaf wykonane są z płyty pokrytej melaminą lub okleiną naturalną, podobnie fronty; dodatkowo zastosować można mdf lakierowany (matowo i w połysku) oraz satynowane szkło malowane w ramach aluminiowych – nowość w ofercie.

The architecture of cabinets and chests of drawers is designed so that they form compositions of particular visual attractiveness and coherence when pieces of different heights are put together; two colours on fronts make an additional illusion of them being merged.

This is an exceptional and original solution.

Cabinet bodies are made of melamine-faced or natural veneer-faced board, just like fronts; additionally, varnished MDF boards (available in matt and gloss) and painted frosted glass in aluminium frames – new in our offer – may be used.











03-01

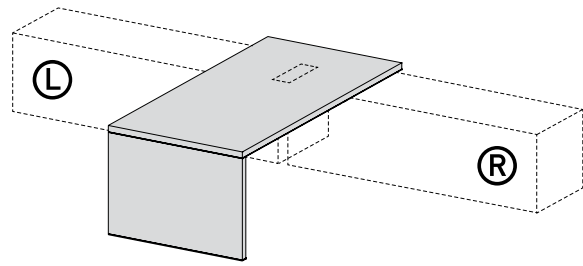

160/90/H74 H78
180/90/H74 H78
200/100/H74 H78
220/100/H74 H78

03-02

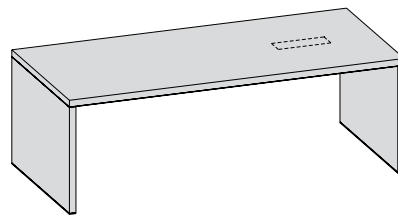

160/90/H74 H78
180/90/H74 H78
200/100/H74 H78
220/100/H74 H78

03-03

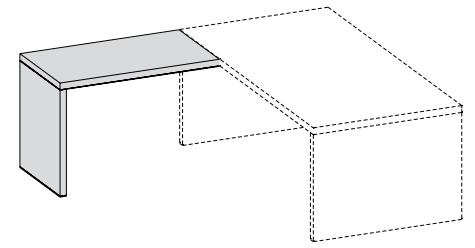

120/60/H74 H78

03-08

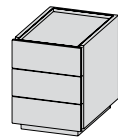

43/60/H58

03-09 (L) (R)

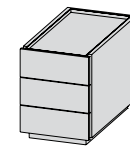

43/80/H58

03-10 (L) (R)

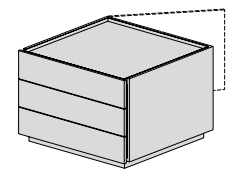

80/80/H58

03-15

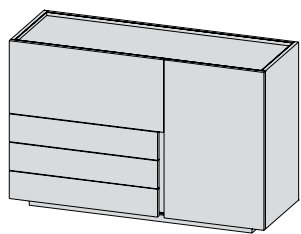

160/55/H103

03-16

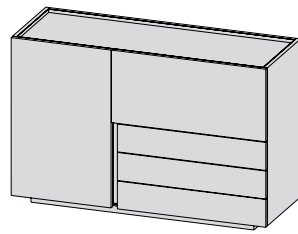

160/55/H103

03-17

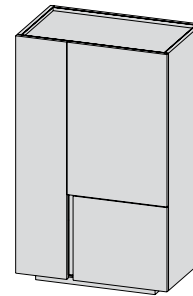

95/55/H152

03-18

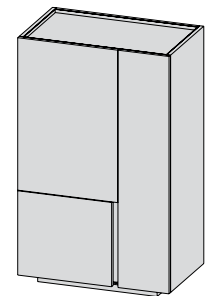

95/55/H152

03-31

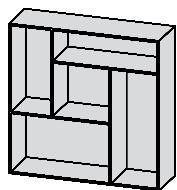

94/25/H94

03-32

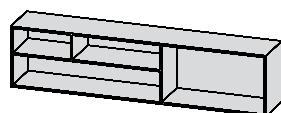

160/25/H38

03-04

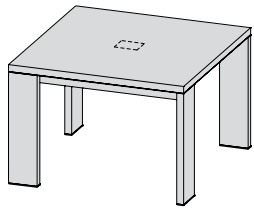

110/110/H74 H78
135/135/H74 H78

03-05

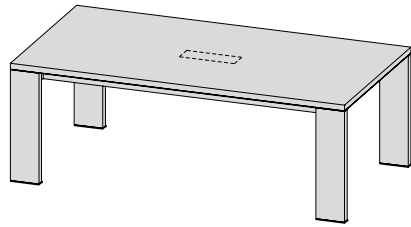

180/90/H74 H78
210/100/H74 H78
240/110/H74 H78

03-06

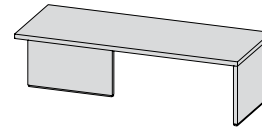

140/55/H35

03-07

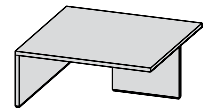

85/85/H35

03-11 (L)

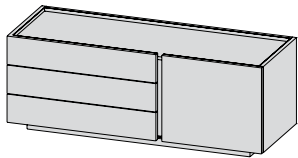

160/55/H58

03-12 (R)

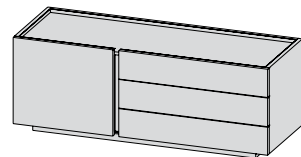

160/55/H58

03-13 (L)

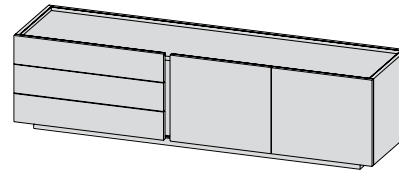

223/55/H58

03-14 (R)

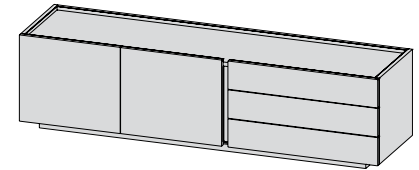

223/55/H58

03-19

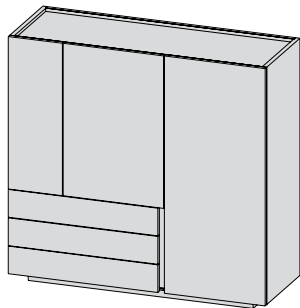

160/55/H152

03-20

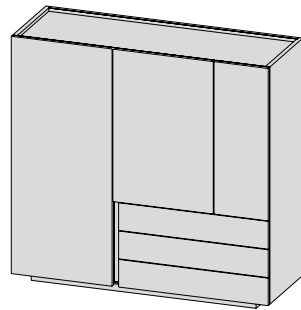

160/55/H152

03-21

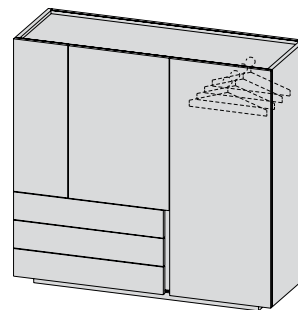

160/55/H152

03-22

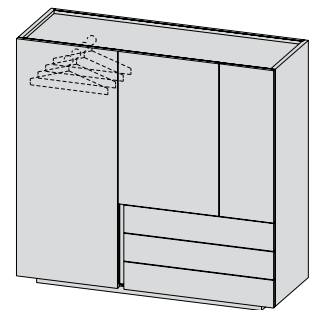

160/55/H152

03-33

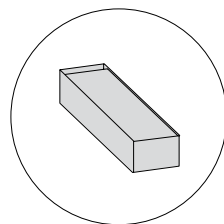

40/14/H14

03-34

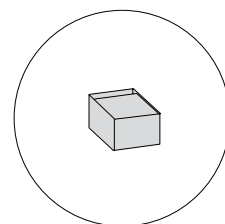

14/14/H14

03-35

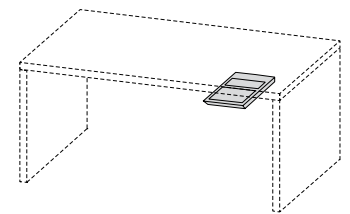

33/39/H5

Projekt katalogu, stylizacja

Catalogue design, styling
Piotr Kuchciński

Zdjęcia

Photography
APT STUDIO

Kolory prezentowane w katalogu mogą się różnić od rzeczywistych. Producent zastrzega sobie prawo do wprowadzenia zmian w kolorystyce, wzornictwie i wymiarach prezentowanych wyrobów.

Niniejszy katalog nie stanowi oferty w rozumieniu prawnym i publikowany jest jedynie w celach informacyjnych. Wszelkie prawa zastrzeżone.

Publikacja: czerwiec 2012

Colours of the shown materials may differ from the real ones. The producer reserves a right to introduce changes of colours, patterns or sizes of the presented Products.

The following pages is not a valid offer and is published Only in informational purposes.
All rights reserved.

Publication: june 2012

BALMA®

FABRYKA MEBLI BALMA SA
UL. POZNAŃSKA 167
62-080 TARNOWO PODGÓRNE
T: +48 61 89 66 400
F: +48 61 89 66 401
MARKETING@BALMA.COM.PL
WWW.BALMA.COM.PL