



ZIG-ZAG





ZIG-ZAG SYSTEM



PLATFORM
4-11



MANAGER
12-19



SINGLE & DOUBLE
20-23

SPACE FOR INTERACT

Zig-Zag is a **perfect solution** for companies in which the basic role fulfill teams consisting of a few persons who need space to interact freely. Desk tops enlarged by add-on devices provide more space and allow a few people to join the

team without any problems and continue collective work. **Module character** of the system and reduced pattern-designing are in accordance with the technical and esthetic needs of contemporary office.







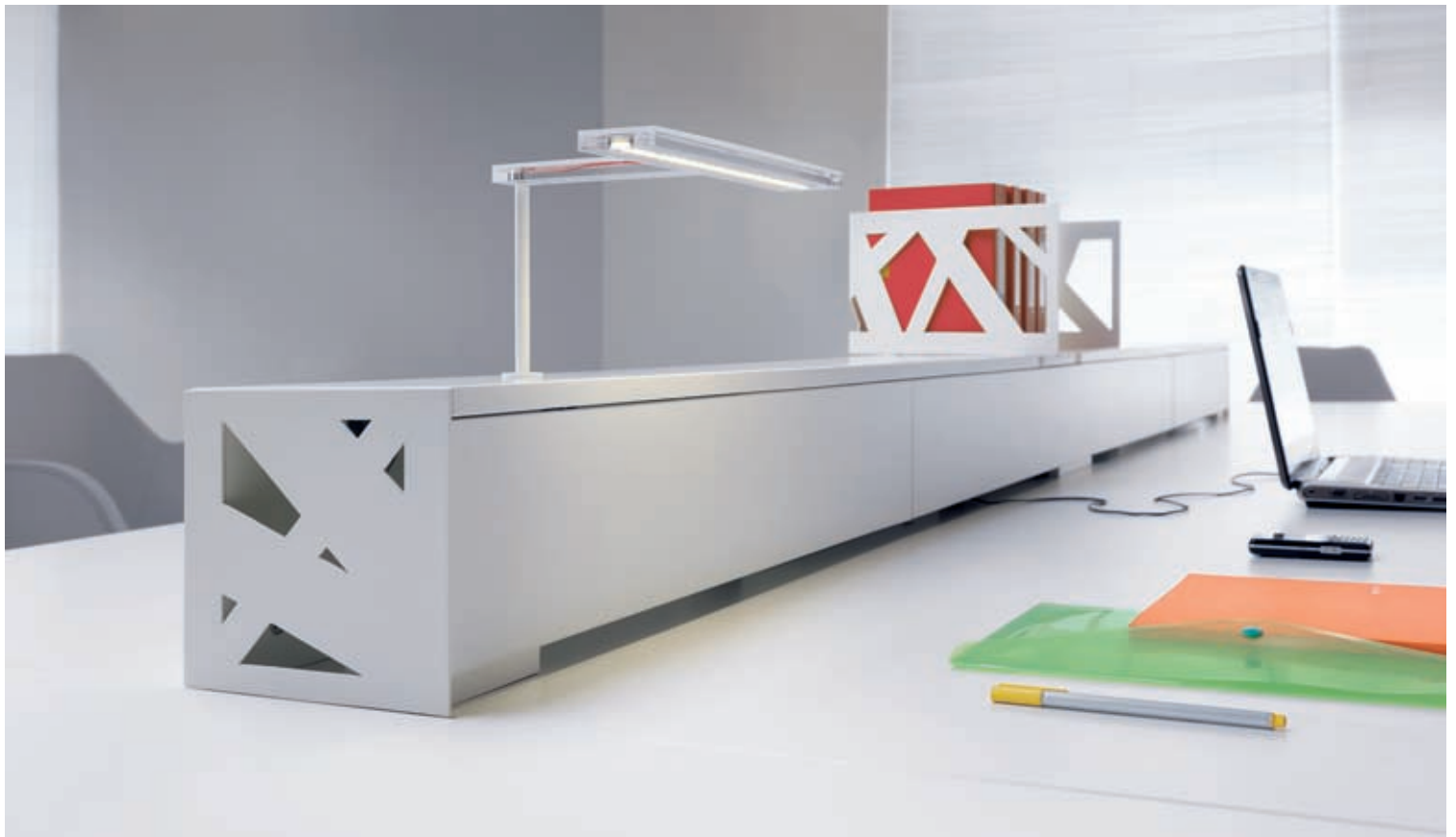

The area for **team work** is often connected with the mobility of the workers. In this case the crucial element shall provide **fast and easy access** to sockets for the workers as well as free communication among the members of the team. Upholstered panels hide media-ports offering

place for accessories and trinkets. On the cover of the panels there are openwork containers for documents and additional sources of light. Due to the abovementioned the workstation becomes **more practical**, comfortable and ergonomic.





All elements which constitute the system are a collection of **basic geometric shapes** of a rectangle and a square. Independent and integrated workstations are connected with the simple shape of a desk top, differentiated only by

the width of the working area. The construction of the desk provides **perfect ergonomics** – a wide area for work, a place for a keyboard and documents, a screen, a telephone and all things which are **essential** for a **modern workstation**.





Zig-Zag **platforms** were designed in such a way to provide quick access and do not cause any problems. That is why they can be exchanged and divide the workstands with a straight or

cross-shaped line. The panels are decorated with ornamented openwork covers made of white metal which fastens the partition and provides a **unique character** of the desk.





White metal **openwork** is a characteristic element of the Zig-Zag system. It is designed in a form of zigzags crossing on the frontal parts of the cupboards, embracing the panels

or decorating the additional accessories. Apart from that, the **mobile container** with a system of quietly closing drawers and a pen box allows to keep stationery in order.





Zig-Zag cupboard connects esthetics and **elegance** with **ergonomics**. Impressive frontal parts with a zigzag pattern cover perfectly designed interior with huge drawers and shelves for files. The system provides a possi-

bility to chose the frontal part of the cupboard due to the arrangement – despite the most characteristic openwork the frontal parts made of melamine of **elegant shining** HPL material are also available.





SPACE FOR IMPRESS

Is a simple, **multifunctional** and comfortable system which matches various offices. Starting from the reception desk through the open staff

rooms to the managers' offices – Zig-Zag creates a **modern office** and provides its unique character.





An opportunity to **concentrate** and have a feeling of **discretion** with being open to the contact with the subordinates is the most crucial element in each office. The workstand for a **manager** in the Zig-Zag system perfectly

fulfills these functions and allows to organize work perfectly. Due to handy additional accessories integrated with the desk the most important elements are always accessible.





SPACE TO CREATE

Zig-Zag perfectly functions in a separate area. It is also an optimal place for a small team. **Integrated workstands** lean against the side extensions and allow to organize work in small rooms with a free exchange of ideas to

solve problems. The main part of the extension can be used also as an additional place for documents or office equipment. The desks are equipped with media-ports providing comfort and access to electricity.



19 20 21 22 23 24 25
26 27 28 29 30 01 02
03 04 05 06 07 08 09
10 11 12 13 14 15 16
17 18 19 20 21 22 23
24 25 26 27 28 29 30
31 01 02 03 04 05 06
07 08 09 10 11 12 13

SYCZEN



The partition walls are very useful in a situation when the performed tasks required concentration and silence. Zig-Zag allows to create **independent boxes** consisting of one or a few workstands, separated with additional panels.

The construction of the partition wall allows to assembly various kinds of shelves and additional accessories over the desk. Next to the desk top there is a shuttered cupboard which can be used as a container.



In case of workstations which are located in independent Bowers the most crucial thing is a possibility to use the sockets and the Internet without any problems. Zig-Zag desks are equipped with comfortable and **accessible media-ports** allowing for a quick connection of the office

equipment with the Internet. Esthetic appearance of the workstation is provided by the canals in the partition walls which hide the cables of the electric and communication network. Due to half-open slats additional devices can be connected without any problems and with-

out the need to disassemble the construction. Additional elements such as hanging shelves or shuttered cupboards complete the system in terms of **functionality** and provide a satisfactory amount of space for documents and files.



DESKS

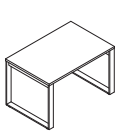

ZBI 02
1200/800/740

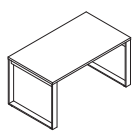

ZBI 04
1400/800/740

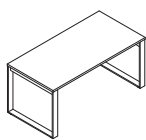

ZBI 06
1600/800/740

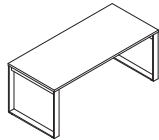

ZBI 08
1800/800/740

EXTENSION



ZPI 016
1618/600/740



ZPI 08
800/600/740

MODESTY PANELS



UH 2
1000/18/400



UH 3
1200/18/400



UH 4
1400/18/400

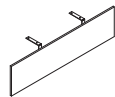

UH 5
1600/18/400

PARTITION WALLS

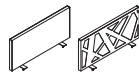

ZP 001
800/36/360

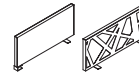

ZP 02
800/36/360

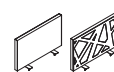

ZP 004
600/36/360

SCREENS



ZP 012
1200/18/350



ZP 014
1400/18/350

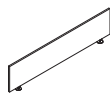

ZP 016
1600/18/350



ZP 018
1800/18/350

PARTITION WALLS WITH PINBOARDS



ZP 012P
1200/46/350



ZP 014P
1400/46/350

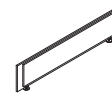

ZP 016P
1600/46/350



ZP 018P
1800/46/350

ACOUSTIC PANELS



RA 12
1200/29/353



RA 14
1400/29/353

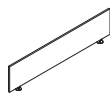

RA 16
1600/29/353



RA 18
1800/29/353

CABINETS

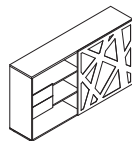

ZS 01
2000/434/1129

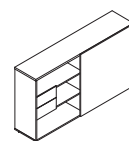

ZS 02
2000/434/1129
HPL front

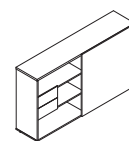

ZS 03
2000/434/1129
melamine front

MOBILE PEDESTALS



SLD 12
416/600/590
SLD 12HT*
416/600/590



SLD 13
416/600/590
SLD 13HT*
416/600/590



ZP 03
400/300/200

SHELF

CONFERENCE TABLE

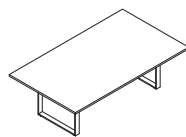

ZBK 01
2400/1400/740

COFFEE TABLE

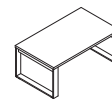

ZBS 10
1200/700/550

*HT top and front with HPL

melamine boards:

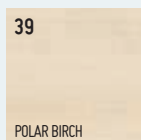
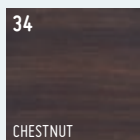
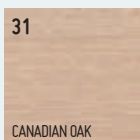
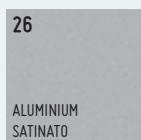

HPL:

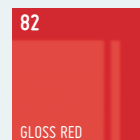

DESKS WITH CABINET

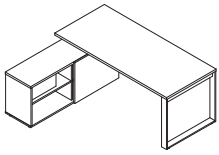

ZBL 10
1800/1902/1600/740

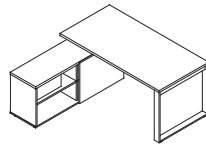

ZBL 11
1600/1702/1600/740

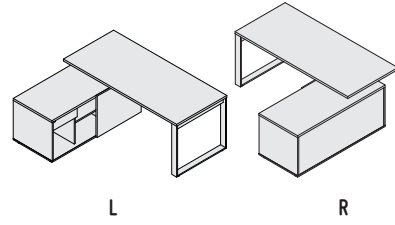

L **R**

DESKS WITH CABINET

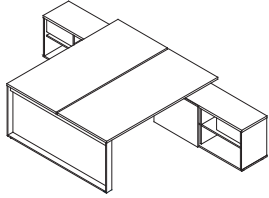

ZBL 020 1800/1902/3218/740

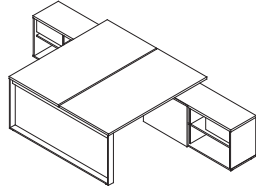

ZBL 021 1600/1702/3218/740

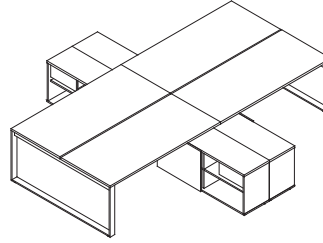

ZBL 040 3600/3804/3218/740

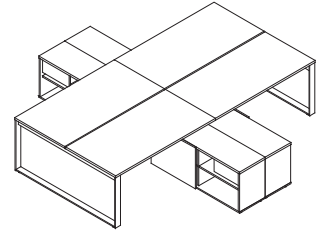

ZBL 041 3200/3404/3218/740

BENCHES

example set:

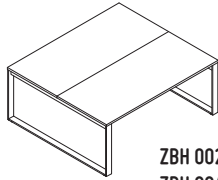

ZBH 002 1200/1618/740
ZBH 004 1400/1618/740
ZBH 006 1600/1618/740
ZBH 008 1800/1618/740

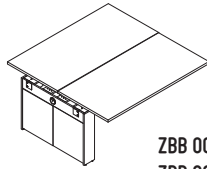

ZBB 002 1200/1618/740
ZBB 004 1400/1618/740
ZBB 006 1600/1618/740
ZBB 008 1800/1618/740

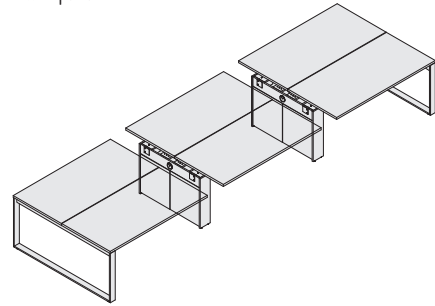

PLATFORM

example set:

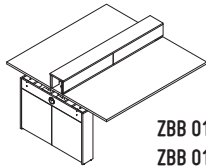

ZBB 014 1400/1618/740
ZBB 016 1600/1618/740

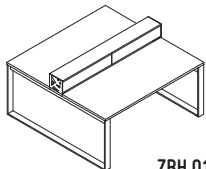
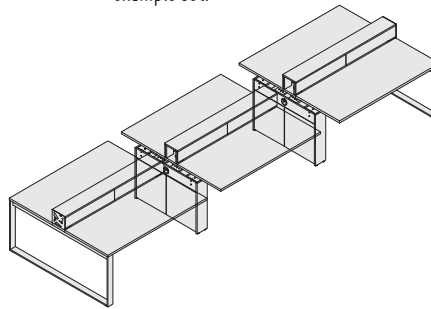

ZBH 014 1400/1618/740
ZBH 016 1600/1618/740

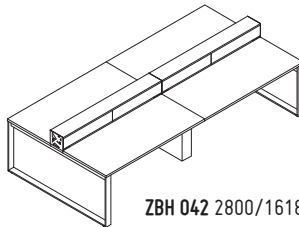

ZBH 042 2800/1618/740
ZBH 044 3000/1618/740
ZBH 046 3200/1618/740

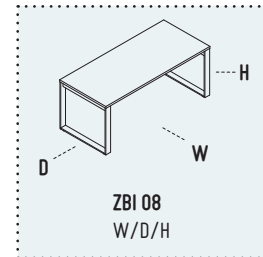

ZBI 08
W/D/H

support frames:

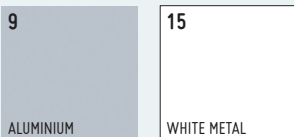

fabrics:



The partner (co-organiser) is IKER a producer of modern upholstery furniture, chairs and lighting. The followings pieces of furniture were used: Lemming, Plumm and Magnetic. We welcome everyone to see the full range of our collection at www.wiker.com.pl



www.mdd.eu info@mdd.eu